

Open Boundary Quad-Ridge Horns

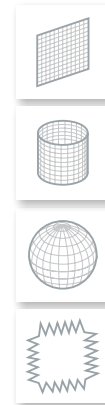

Typical 3D co-polarization radiation pattern

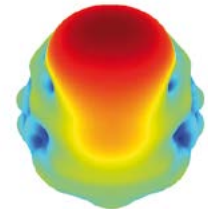

Typical 3D cross-polarization radiation pattern

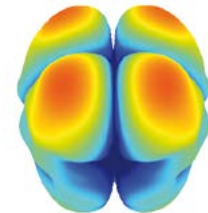

SOLUTION FOR

- Low frequency PNF/CNF measurements
- Wideband antenna measurements in SNF and CATR systems
- Reflector feeds for high gain applications

Main features

Technical performance

- Dual linear polarization with high polarization purity and isolation
- Low return loss / VSWR
- Wide bandwidth

Design

- Unique design preventing the excitation of unwanted higher order modes in the aperture
- Well-defined smooth radiation pattern throughout the operational bandwidth
- Lightweight for easy handling

Surface treatment

- Surtec 650 according to MIL-C 5541E class 3
- Polyurethane paint

Repeatability

- Stiff and robust mechanical design
- Standard MVG circular interface for precision centering
- Precision pins for accurate polarization alignment
- Precision machined
- High reliability coaxial connector

Delivered documents

- Typical performance data (TYMEDA™)
- Measured return loss data and port-to-port coupling

Product configuration

Equipment

- Mounting flange
- Integrated coaxial transition with high precision connector
- Circular polarization available with external hybrid coupler
- Protective radome for outdoor installation

Related services

- Calibration and maintenance
- Customization

■ Included □ Optional

USED4TEST

Телефон: +7 (499) 685-7744

used@used4test.ru

www.used4test.ru

Electrical characteristics

Part number	QH100	QH400	QH800	QH1400	QH2000	QH4000	QH18000
Type of antenna	Open boundary quad-ridge horn	Open boundary quad-ridge horn	Open boundary quad-ridge horn	Open boundary quad-ridge horn	Open boundary quad-ridge horn	Open boundary quad-ridge horn	Open boundary quad-ridge horn
Frequency range	0.1 – 1.5 GHz	0.4 – 6 GHz	0.8 – 12 GHz	1.4 – 22 GHz	2 – 32 GHz	4 – 40 GHz	18 – 50 GHz
Gain	4.5 – 15.8 dBi	4 – 15 dBi	5 – 15 dBi	2 – 15 dBi	3 – 16 dBi	5 – 16 dBi	6 – 12.5 dBi
VSWR	< 1.9	< 1.9	< 1.9	< 3.5 [1.4 – 3 GHz] < 1.9 [3 – 22 GHz]	< 2.5 [2 – 4 GHz] < 1.9 [4 – 32 GHz]	< 3.5 [4 – 5 GHz] < 1.9 [5 – 37 GHz] < 3.5 [37 – 40 GHz]	< 2.6
Return loss	< -10 dB	< -10 dB	< -10 dB	< -5 dB [1.4 – 3 GHz] < -10 dB [3 – 22 GHz]	< -7 dB [2 – 4 GHz] < -10 dB [4 – 32 GHz]	< -5 dB [4 – 5 GHz] < -10 dB [5 – 37 GHz] < -5 dB [37 – 40 GHz]	< -7 dB
Polarization	Dual linear	Dual linear	Dual linear	Dual linear	Dual linear	Dual linear	Dual linear
Cross-polar discrimination	> 30 dB	> 30 dB	> 30 dB [0.8 - 10.8 GHz] > 25 dB [10.8 – 12.0 GHz]	> 25 [1.4 – 2 GHz] > 30 dB [2 – 22 GHz]	> 30 dB	> 30 dB	> 30 dB
Port-to-port isolation	> 30 dB	> 30 dB	> 30 dB [0.8 – 10.8 GHz] > 25 dB [10.8 – 12.0 GHz]	> 30 dB	> 30 dB	> 30 dB	> 30 dB
Impedance	50 Ohms	50 Ohms	50 Ohms	50 Ohms	50 Ohms	50 Ohms	50 Ohms

QH400 electrical performance

Boresight gain

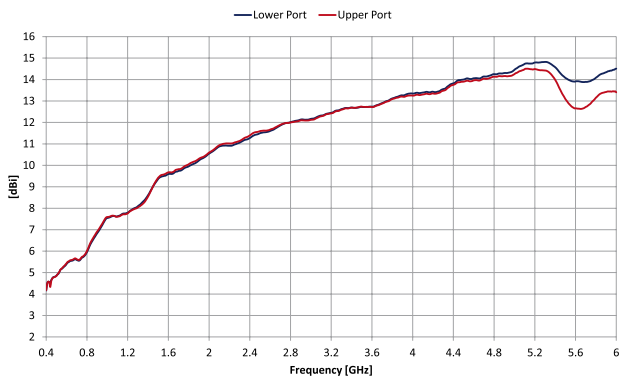

Return loss and port-to-port isolation

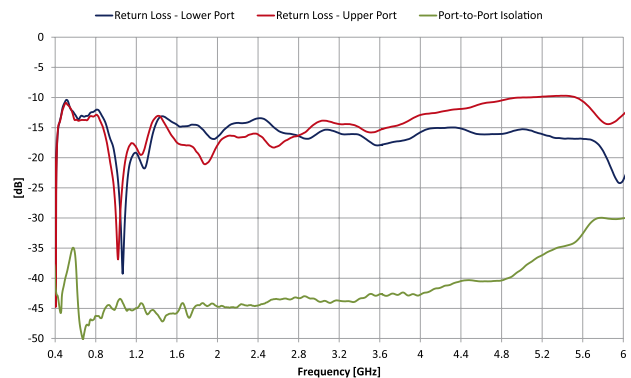

Radiation pattern - upper port - 3 GHz

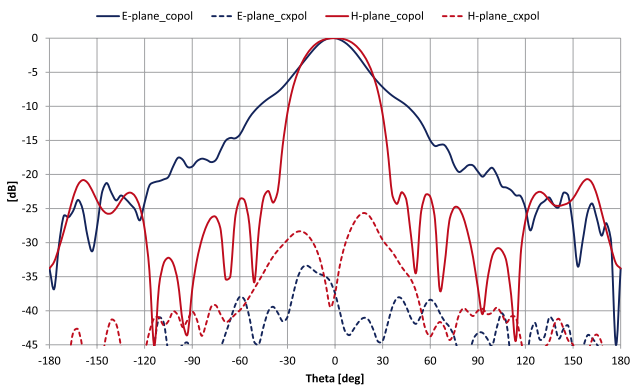

Radiation pattern - lower port - 3 GHz

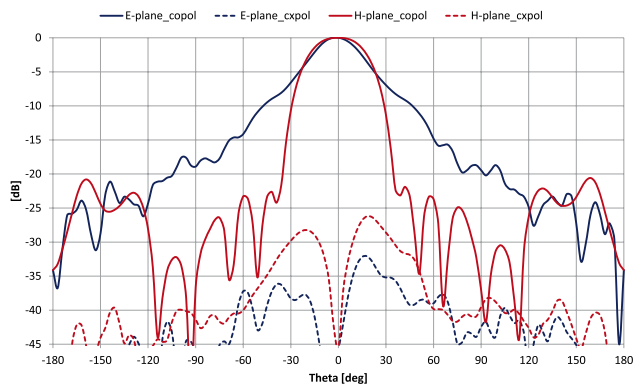

QH800 electrical performance

Boresight gain

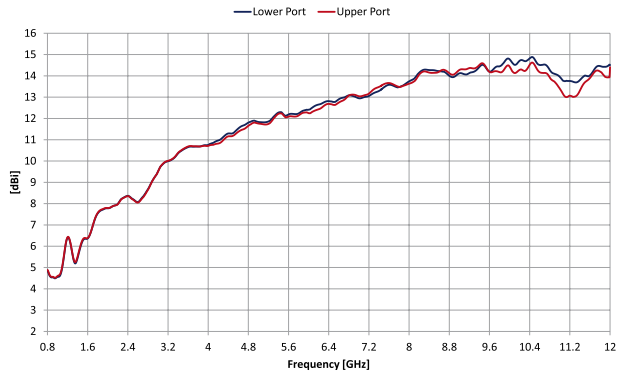

Return loss and port-to-port isolation

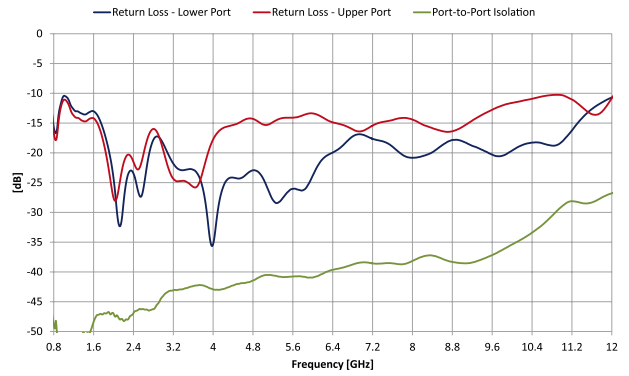

Radiation pattern - upper port - 3 GHz

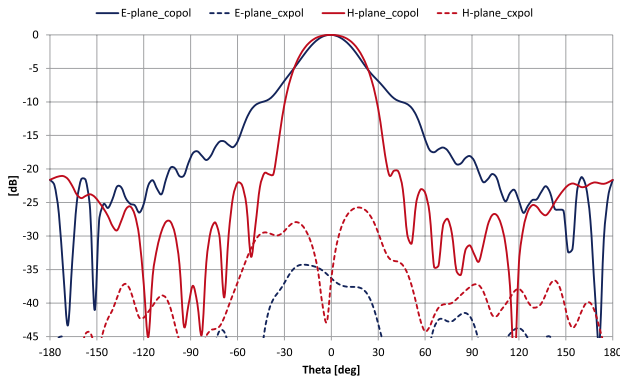

Radiation pattern - lower port - 3 GHz

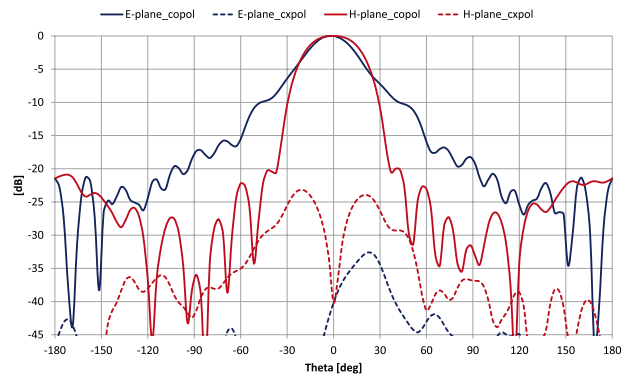

QH2000 electrical performance

Boresight gain

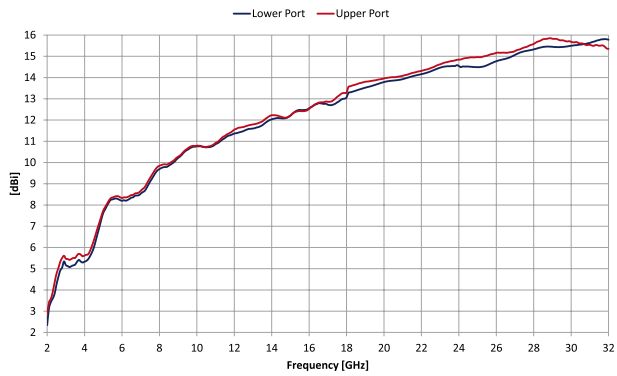

Return Loss and port-to-port isolation

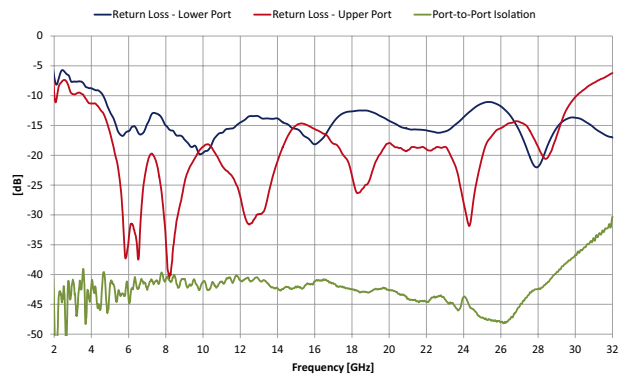

Radiation pattern - upper port - 3 GHz

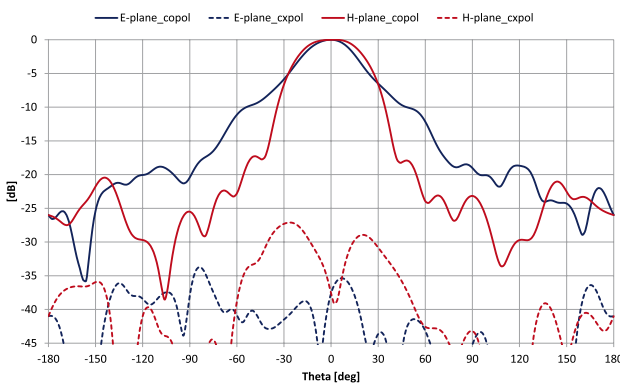

Radiation pattern - lower port - 3 GHz

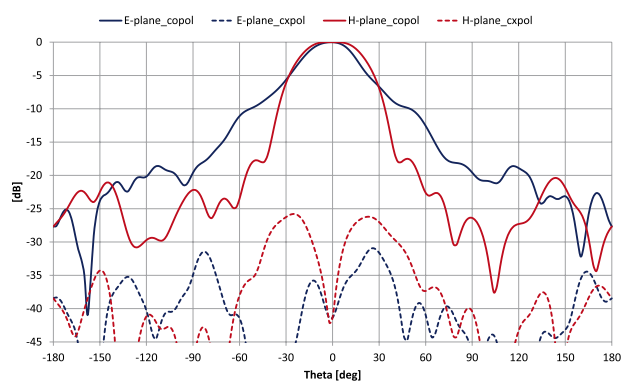

Mechanical characteristics

Part number	QH100	QH400	QH800	QH1400	QH2000	QH4000	QH18000
Dimensions [mm] (H x W x L)	1950 x 1950 x 1680	527 x 527 x 462	264 x 264 x 245	151 x 151 x 168	105 x 105 x 110	90 x 90 x 110	60 x 60 x 72
Weight (approx.)	60 Kg	5 Kg	1.2 Kg	0.62 Kg	0.24 Kg	0.24 Kg	0.12 Kg
RF connector	N Female ⁽⁴⁾	3.5 mm Female ⁽¹⁾	3.5 mm Female ⁽¹⁾	3.5 mm Female ⁽¹⁾	3.5 mm Female ⁽¹⁾	2.92 mm Female ⁽²⁾	2.4 mm Female ⁽⁵⁾
Material	Aluminum	Aluminum	Aluminum	Aluminum	Aluminum	Aluminum	Aluminum
Treatment	Surtec 650 ⁽³⁾	Surtec 650 ⁽³⁾	Surtec 650 ⁽³⁾	Surtec 650 ⁽³⁾	Surtec 650 ⁽³⁾	Surtec 650 ⁽³⁾	Surtec 650 ⁽³⁾
Interface	Circular Ø 450 mm	Circular Ø 110 mm	Circular Ø 110 mm	Circular Ø 60 mm	Circular Ø 60 mm	Circular Ø 60 mm	Circular Ø 60 mm

(1) Huber & Suhner type 23 PC35-50-0-51/199 UE

(2) Southwest Microwave type 1012-16SF

(3) Equivalent to MIL-C 5541E class 3

(4) Southwest Microwave type 312-04SF

(5) Southwest Microwave type 1430-00SF

Dimensional drawing

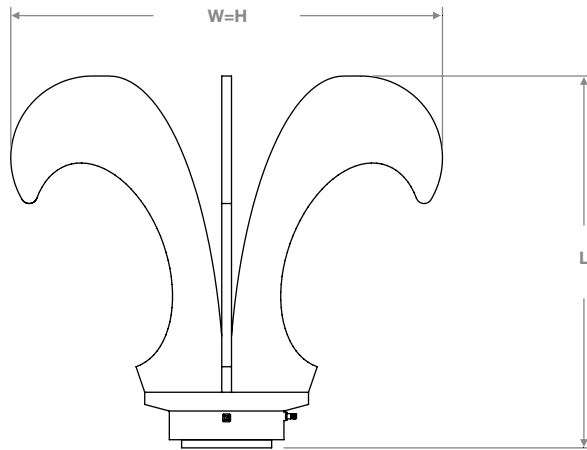

QH100 interface

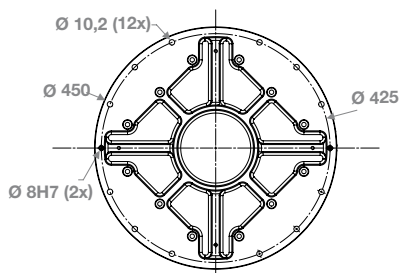

QH400, QH800 interface

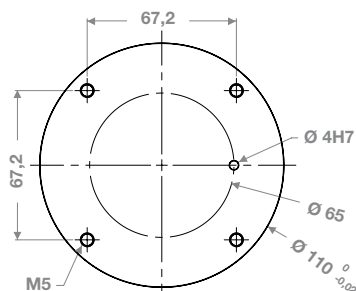

QH1400, QH2000, QH4000, QH18000 interface

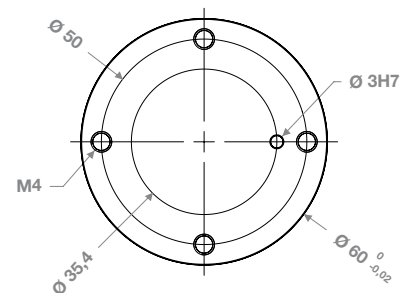

Solutions For Outdoor Installation



The MVG protective radomes are designed to fit Open Boundary Quad-Ridge Horns, allowing outdoor installation with minimum impact on electrical performance. The materials and coating employed provide hydrophobic properties and good UV stability, low relative permittivity and low dielectric loss, therefore offering an effective protection in outdoor conditions and good RF transparency. The radome enclosures are also equipped with pressure equalizing vents to reduce condensation caused by rapid changes in temperature, while preventing water and dust ingress.

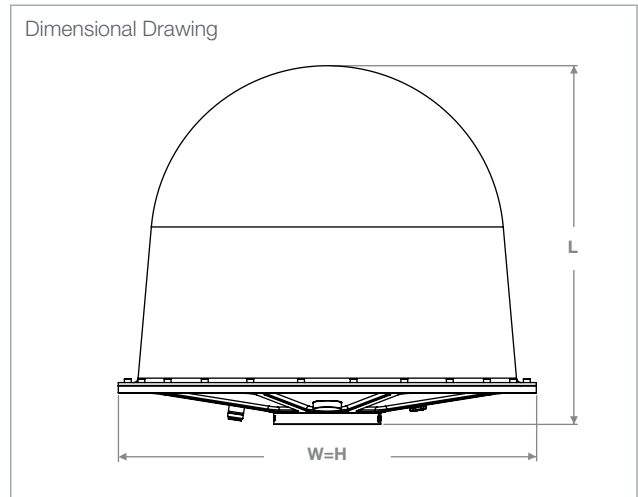

Mechanical characteristics

Part number	R430	R175
Featured quad-ridge horn	QH800	QH2000, QH4000
Dimensions (H x W x L)	430 x 430 x 369 mm	199 x 199 x 190 mm
Weight (approx.)	4 Kg	0.9 Kg
Materials	Aluminum, PVC, GFRP	Aluminum, Dyneema™
Color	White	White
Connector	N-type Female – sealed ⁽¹⁾	2.92 mm Female ⁽²⁾
Interface	Circular Ø 110 mm	Circular Ø 60 mm
Ingress protection	IP67	IP67
Wind rating ⁽³⁾	160 km/h	160 km/h

(1) Inmet/Aeroflex 5217

(2) H&S 34-SK-50-0-54-199_NE

(3) Based on FE (Finite Element) analysis in accordance to UNI EN 1991-1-4 EUROCODE 1



USED4TEST

Телефон: +7 (499) 685-7744

used@used4test.ru

www.used4test.ru